

**DIMENSION**

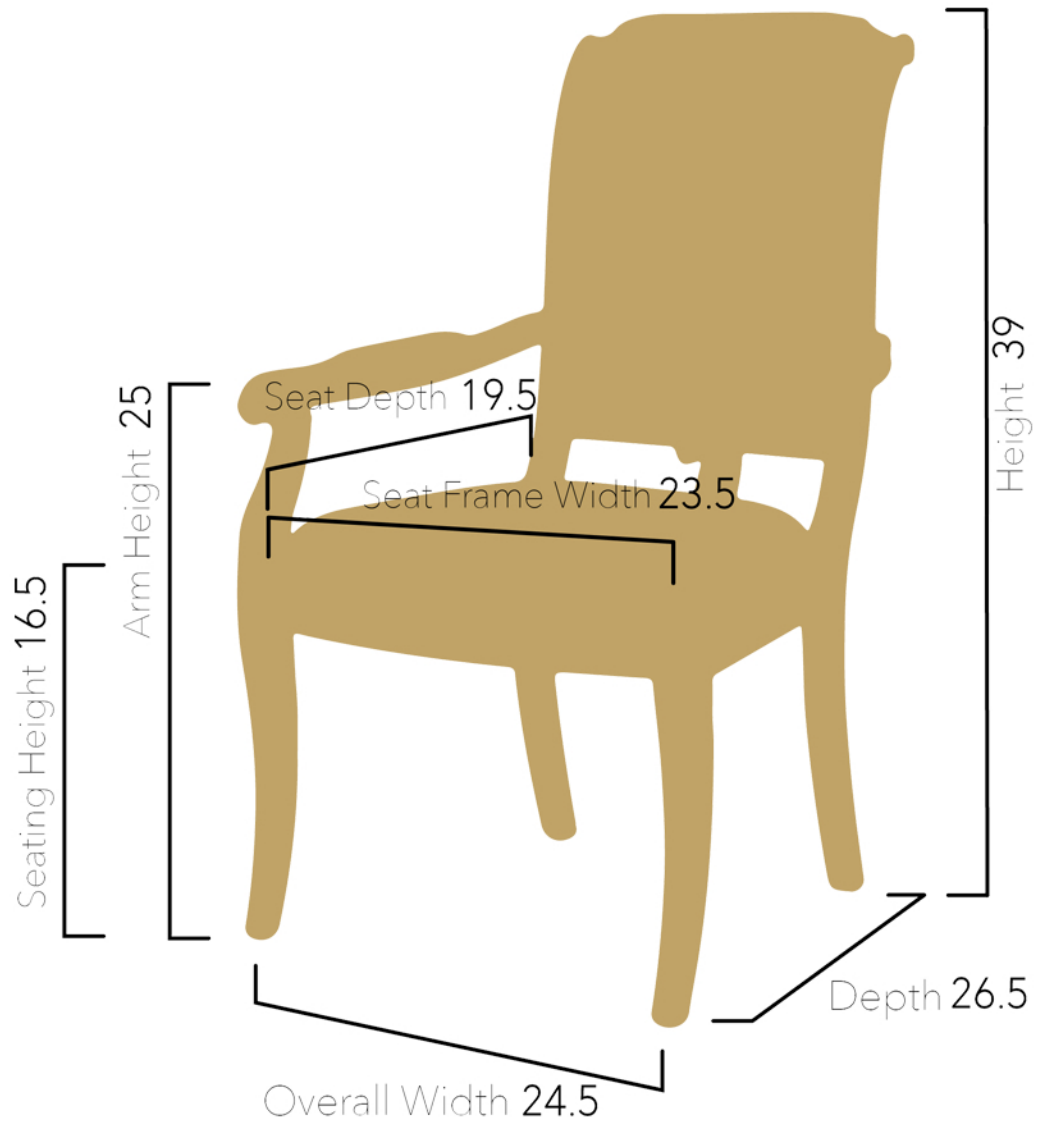

**FABRIC  
 REQUIREMENT**

	TOTAL SOLID FABRIC		TOTAL CENTER PATTERN		SEAT		FOB		BOB		INSIDE WING		LEATHER	
	Mtr	Yard	Mtr	Yard	Mtr	Yard	Mtr	Yard	Mtr	Yard	Mtr	Yard	Sq Mtr	Sq Ft
ARM	1.15	1.3	1.7	1.8	0.40	0.4	0.45	0.50	0.3	0.33			2.0	21.5
SIDE	1.05	1.2	1.5	1.7	0.35	0.4	0.40	0.44	0.25	0.28			1.8	19.4